

MIKUNI

PAT UPGRADE

INSTALLATION SUPPLEMENT

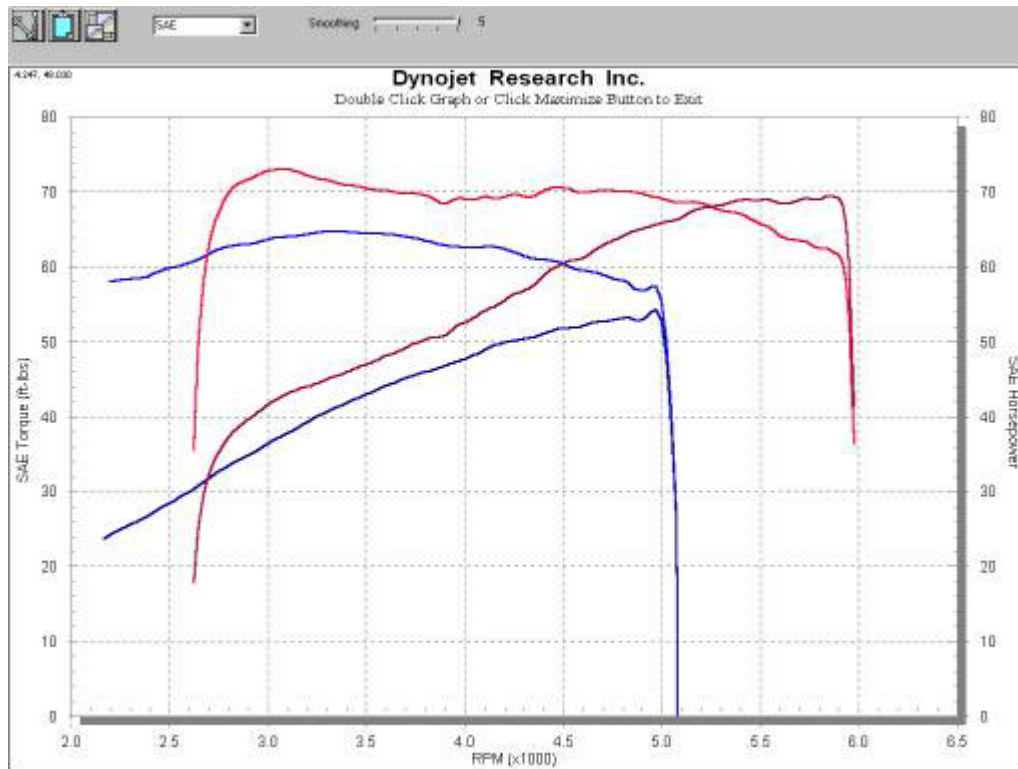

The above picture is a “screen shot” of two Dynojet test runs. This is a true and un-altered illustration of the performance improvement the PAT Upgrade kit can make. The two curves that rise sharply on the left side are the torque lines for the stock and PAT versions. The two curves that start low on the left are the stock and PAT horsepower tracks. The stock engine quits at a bit over 5,000 rpm because of its rev-limiter. The PAT version of the same engine continues to build power to 5,800 rpm where its rev limiter cuts in. Note the long, high shape of the PAT torque curve; this illustrates the very wide power band of the PAT equipped motor. Note also that there are no dips or ‘holes’ in the power curve.

Ver 3.0 Sept.'99

MIKUNI PAT UPGRADE: INTRODUCTION

Installation of the Mikuni PAT Upgrade kit is straight-forward in that no special or unusual procedures are required. Mikuni's HSR42 carburetor has been fitted to many thousands of Harley-Davidson motorcycles by moderately experienced owners. Installation of the Mikuni/CompuFire ignition is uncomplicated and straight-forward. In fact, it is easier to install the ignition than to remove and re-fit the original Harley sensor assembly.

Camshaft installation, on the other hand, is a relatively complex procedure. Several of the operations involved in replacing Big Twin cams must be done rather carefully, using special tools and, preferably, by an experienced Harley mechanic. For that reason, Mikuni strongly recommends that the PAT Upgrade kit be installed by an experienced professional.

Anyone who works on any motorcycle should have a factory shop manual for that motorcycle at hand.

Why the Mikuni PAT Upgrade works:

The maximum horsepower your engine can make is determined by how much air passes through it and by how efficiently it uses that air to produce power and deliver it to the ground. More air flow and/or greater efficiency means more power.

Maximum air flow is determined by every and all engine components that it passes through (air cleaner, carburetor, intake manifold, intake port, combustion chamber, exhaust port and exhaust system). Any one of those components can act as a restriction to air flow and, therefore, power. A restrictive air cleaner or exhaust system will limit maximum power output, no matter what cam or carburetor is fitted.

Equally important to free air flow is timing: when the air is allowed to flow (cam & exhaust design) and when the fuel/air mixture is fired (ignition timing).

Over-all optimum performance is a complex combination of factors: cam timing, air flow characteristics, ignition timing and exhaust system design (air flow and sound wave dynamics). No one of these factors is solely responsible for good engine performance. They must all work together.

Our Mikuni PAT Upgrade kit has been carefully developed to maximize both air flow and combustion efficiency over the widest possible rpm range. The Mikuni carburetor, cam and ignition all work together to give the widest power band of any combination of Evo engine tuning components available.

Air cleaner choices:

We recommend one of three air cleaner combinations for use with the Mikuni PAT Upgrade kit:

- 1) The stock ('90 or later) air box with a K&N replacement filter and the (furnished) Mikuni air cleaner cover. This combination is the quietest.
- 2) A Harley-Davidson "Screamin' Eagle" air cleaner kit.
- 3) Mikuni's air cleaner assembly.

All three air cleaner combinations produce the same performance (power) from 3,000 to 5,000 rpm. The modified stock air cleaner assembly is the quietest and makes the most power below 3,000 --- where it matters most. At our red line of 5,800 rpm, the Mikuni air cleaner will deliver about 3 more horsepower than the modified stock combination. At the same 5,800 the Screamin' Eagle air cleaner will produce 1 or 2 more than the modified stock combination.

Very few of us can detect the difference between 68 and 72 horsepower when it only occurs at the very last couple of hundred rpm before the rev limiter cuts in (or is it out?). So, if you prefer a quiet intake and want the most useful power, stick with the modified stock air cleaner assembly. If you already own a Harley-Davidson Screamin' Eagle air cleaner kit and do not mind a little intake hiss, go ahead and use it. Our air cleaner kit will make, by a small margin, the most peak power.

Exhaust system choices:

Touring models:

Kerker/Mikuni:

You will get the most torque at the lowest rpm (2,800) and the most peak horsepower (68@5,800) with the stock header pipes and the Kerker/Mikuni mufflers. These mufflers are externally identical to the Kerker/Harley after market touring mufflers sold exclusively through Harley dealers for more than 10 years. They are mechanically reliable; there will be no cracking or rusting. Kerker mufflers are of the highest quality and we are pleased that Kerker has agreed to support the PAT Upgrade by providing this special muffler set.

The key to the Kerker/Mikuni mufflers' superior performance is the baffle design. Our baffles allow very high exhaust gas flow rates. Their shape and position in the muffler bodies help develop the very high torque at very low rpm that is unique to the PAT Upgrade kit.

Other exhaust systems may produce quite good results although it is unlikely that they will develop the power spread of the Kerker set. On the whole, large diameter mufflers with large i.d. baffles perform better than small diameter mufflers. Also, perforated baffle tubes (punched holes) are, size-for-size, less restrictive than louvered baffle tubes.

Alternate systems & how to choose them:

Header Pipes:

The following recommendations are based on many, many dyno runs and the experience of a number of recognized and experienced engine tuners, as well as the example of the factory itself. If you follow these principles in selecting header pipes and mufflers, your engine will run quite well.

Header pipes: the best all-round header pipes are the factory stock pipes. Header pipes should be 1-3/4" in diameter and 27 to 32 inches long (from the mouth of the pipe where it joins the head to the end where it ends or enters the muffler).

Extensive dyno testing indicates that 29 inches is the best length. A Big Twin that makes 60 horsepower with 29" pipes will lose about one horsepower with 27" pipes. It will also lose about one horsepower with 32" pipes. Power losses go up dramatically with pipe lengths outside this range.

Straight pipes will not run well at lower rpm. 29" long by 1-3/4" diameter straight pipes will make excellent power above 3,800 rpm but they perform badly below that engine speed. Long (36-40") straight pipes are death to good tuning and real power at any rpm.

Mufflers:

The main performance problem with Harley mufflers is size. Few of us care to mount mufflers on our Hogs that are large enough to maximize both power and silencing. Harley's stock non-touring mufflers (small and quiet) restrict air flow and therefore power. Typical small high flow "slip-on" mufflers are loud and still do not maximize power. The fundamental, underlying reason for the Kerker/Mikuni muffler's success is its size. Sufficiently large mufflers can be both quiet and powerful.

Most small slip-on mufflers will perform rather well if they can be seen through. That may seem like an over simplification, but ---- the dyno says otherwise. Straight-through mufflers perform reasonably well. The larger the hole through the muffler, the more power (and noise) it will make.

The difference in performance between the worst and best of the small slip-on mufflers is only a handful of horsepower. So, pick the set you prefer to look at and enjoy them.

PERFORMANCE:

Torque & Horsepower:

As can be seen in the accompanying dyno chart, Mikuni's PAT Upgrade very substantially improves torque and horsepower throughout the engine's operating range.

If your engine is in good condition when you install the Mikuni PAT Upgrade, it will deliver power very much like what is shown on the dyno chart.

Mufflers or an air cleaner other than what we recommend will remove some of the torque at the lowest rpm and horsepower from the top 500 rpm or so.

Response & Driveability:

The dyno only tells part of the story. Dynamometer tests are nearly always made at full throttle. While such tests clearly indicate how much power an engine will deliver at the drag strip, they do not give more than a slight clue about how an engine will respond when the rider applies part throttle from low rpm. It is the performance of an engine at part throttle and low-to-mid rpm that we are most aware of; it is what we use every day when we ride.

The main goal of the Mikuni PAT Upgrade kit team was to produce an engine package that would give the very best possible throttle response and low-to-mid rpm power. Peak power output was not our main consideration and we would have been satisfied with 65 horsepower. That the PAT Upgrade produces nearly 70 horsepower is a pleasant bonus. We did accomplish our goal. A PAT equipped Harley-Davidson has superb throttle response and mid-range power!

Our kit's extraordinary real-world, part throttle performance is due to a combination of its unique features. Our carburetor is the most responsive available, bar none. Our ignition has an aggressive advance curve which helps produce maximum performance and response at low rpm and light throttle settings. The PAT camshaft design was optimized for power band width. We could have made more peak power. Instead, we choose to develop a cam that would deliver its best performance where the vast majority of our Harley engines spend their running life.

We are confident that you will find that the PAT Upgrade delivers on our promise: to give you the best all-round Evolution Harley-Davidson engine possible.

CAM INSTALLATION GUIDE:

Mikuni's PAT cam was designed and developed to be an integral part of the Mikuni PAT Upgrade kit. The impressive performance of the PAT Upgrade is the result of all the separate components, PAT cam included, working in harmony. With our special ignition, a correct exhaust and, of course, our superb HSR42 carburetor the PAT cam delivers superior torque and horsepower over the widest range of any combination of tuning parts available.

The PAT cam is mechanically quiet. If the gear from your stock cam is fitted to the PAT cam (a common procedure in most shops), it is unlikely that you will notice any difference in valve noise at all. It is not necessary to replace the valve springs when installing the PAT cam.

The PAT cam is reliable. At any given rpm it places little if any more strain on the valve gear than does the stock Harley-Davidson camshaft. The PAT cam is produced to our specifications, by Andrews Products, one of the most reliable and respected cam grinders in the world.

INSTALLATION NOTES:

The Mikuni PAT camshaft is a bolt-in cam. Its installation does not require permanent modifications to the engine. And, the procedure is no more difficult than replacing a stock camshaft. However, the special tools and skills needed to properly install any cam in an Evo engine place the procedure beyond the practical abilities of the great majority of Harley owners. For that reason our instructions are limited to those that might be useful to an experienced mechanic.

CAM BEARING:

Since 1993 Harley-Davidson has been installing camshaft needle bearings that are not tough enough to reliably carry the loads associated with higher rpm and more aggressive camshafts. Many of these new production bearings have been failing in the field, even with stock cams.

This new ('93 & later) bearing incorporates a needle retainer and, consequently, has fewer needle rollers to carry valve gear loads. It is imperative that stock '93 and later camshaft needle bearings be replaced with the earlier Timkin B138 "full compliment" bearing included in the Mikuni PAT Upgrade kit. Unless the stock bearing is replaced with the furnished bearing, it is likely that the bearing will fail and cause major damage to the engine.

Harley switched to the "INA" style bearing because it is less sensitive to cam/bearing alignment. They apparently found alignment to be a greater problem than load carrying capacity. It is very important that the furnished Timkin bearing be held in close alignment during installation. We recommend the JIMS "Inner Cam Bearing Installation Tool" (p/n 2188) for this task. The JIMS "Big Twin Bearing Puller" (p/n 957600-TB) also makes cam bearing removal a quick and reliable operation, (805) 482-6913.

CAM GEAR:

Harley-Davidson supplies several different sizes of crankshaft (pinion) and cam gears. These are assembled into engines in matched sets so that the valve gear will be quiet in operation. The valve train rattle that so often appears after an aftermarket cam installation is usually due to a mismatch of cam and pinion gear sizes.

Aftermarket cam manufacturers must cut their cam gears on the small-side to avoid possible gear and engine damage. The common result of this precaution is valve gear rattle. If the cam gear were to be too large, both gears would be damaged or even destroyed with dire consequences to the engine.

If the stock cam gear is pressed onto our PAT camshaft, it will ensure that the cam/pinion gear set will match and that the valve train will be as nearly silent as possible.

CAM GEAR HOW TO:

1. Scribe two marks on the stock cam gear in the corners formed by the gear and the notch cut into the camshaft. A sharply pointed scribe will improve accuracy by getting further into the corners formed by the notch and gear.
2. Press the marked gear off the stock cam.
3. Press the gear off the PAT cam.
4. Align the marks on the stock gear with the notch in the PAT cam and press the gear onto the cam.

NOTE: This is a surprisingly accurate procedure. If neither of the scribe marks are covered after installation of the gear, the cam will be within ½ crankshaft degree of being perfectly located.

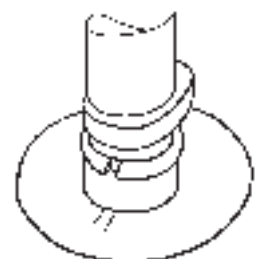
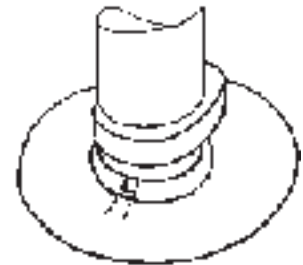

END PLAY HOW TO:

Camshaft end play should be set to approximately .010". Doing so will accomplish several things: It will remove a common source of mechanical noise. It can reduce side loads on the tappets. It will ensure that the ignition rotor cannot contact the back of the ignition module.

With the tappets removed from the engine, slip the camshaft together with the "cam gear thrust washer" into the case. Refit the cam cover with the original cam cover gasket. Fit and snug two or more screws.

Use a feeler gauge set to measure cam end play. Install an appropriate shim (H-D p/n 25550- to 25559-) to bring the end play close to .010".

Once the end play is set, reassemble the cam, tappets and cam cover in the normal manner. Use the new gasket during final assembly.

NOTE: If you use a new gasket during this procedure (new motorcycles with chromed cam covers often seal quite well with the original gasket), set the end play to about .014" as the new gasket will crush approximately .004" after some use.

PUSHROD ADJUSTMENT:

The pushrod set included in the PAT Upgrade kit is made by Andrews Products and is their standard aluminum set for the Evolution Big Twin. The longest of the four pushrods operates the front exhaust valve. The middle-length pushrod operates the rear exhaust valve. The two shortest pushrods are equal in length and operate the intake valves

IGNITION INSTALLATION:

NOTE:

- You must unplug the stock ignition module before proceeding with the installation of the Mikuni ignition module. The stock module is not required and may be removed.
- We recommend the use of resistor-core high tension (spark plug) wires and resistor-type spark plugs, both are standard on all Harleys. It is possible that solid wires might cause misfires with our ignition.

CAUTION:

- If either of the other wires (black or green) touches the positive terminal of the battery, the ignition will be destroyed!
- Harley's hot (+) coil wire is color coded white/black ("W/BK"). Be certain that you connect the PAT ignition's red wire to the Harley W/BK coil wire. If the ignition is connected backwards, it will be destroyed.

HOW TO:

- 1) Set the TDC mark on the crankshaft in the center of the timing hole with the notch in the end of the cam pointing down and to the left. If the notch is to the upper right, rotate the crankshaft one full turn and again center the TDC mark in the timing hole.
- 2) Place the trigger rotor on the cam with its locating pin in the notch. Secure the rotor with the socket head screw, washer and a drop of blue Loc-Tite. Torque to 25 inch pounds.
- 3) Feed the ignition wiring cable through the hole in the cam cover and gently pull it through. Align the "V" notch in the ignition plate with the hole and the cable. Slide the ignition module into place in the cam cover. Leave enough cable to form a small loop inside the cam cover.
- 4) Install the ignition retaining screws (standoffs). Do not use washers under the screws. Snug the screws so that the ignition can rotate smoothly yet with minimal play.

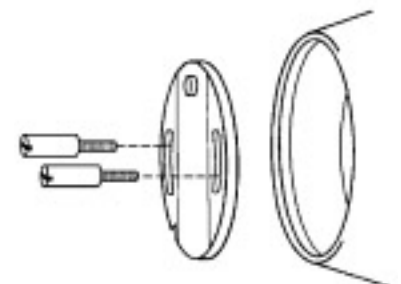
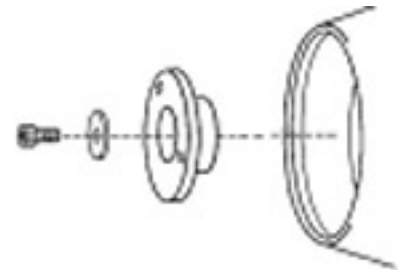
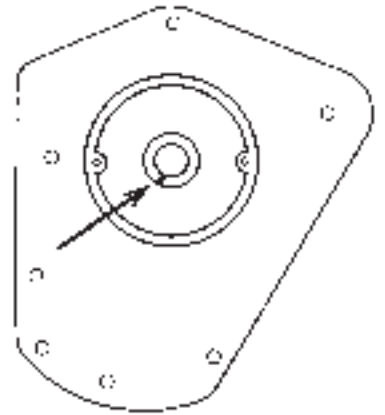

- 5) Rotate the ignition counter clockwise (retard) as far as it will easily go. Be sure the ignition switch is off. Connect the red wire from the ignition module to the positive terminal of the battery. Connect battery ground cable.

Caution: If either of the other wires (black or green) touch the positive terminal of the battery, the ignition will be destroyed! Remove insulation from the red wire only, until final assembly, to help prevent accidental contact with the battery.



- 6) The static timing light mounted in the upper RH portion of the ignition module may be on or off. If it is on, use the supplied magnet stack to turn it off. To do this, place the magnet (orange dot facing out) against the module in the area shown.

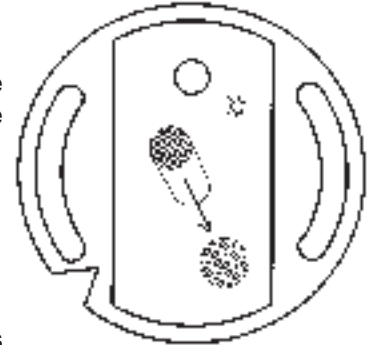

- 7) Slowly and smoothly rotate the ignition to the right (clockwise) until the LED just turns on. You may want to repeat this procedure a time or two just to be sure that you have stopped rotating the ignition just as the LED lights up. A small mark made with a felt-tip pen at the ignition/case junction allows for easy repeatability checking.

NOTE: We have found this static timing technique to be very reliable and accurate. However, if you wish to double check the timing with a light, be sure to disconnect the V.O.E.S. (green) wire and rev the engine to slightly more than 3,500 rpm so that the ignition is fully advanced. Time the engine on the normal full advance mark.

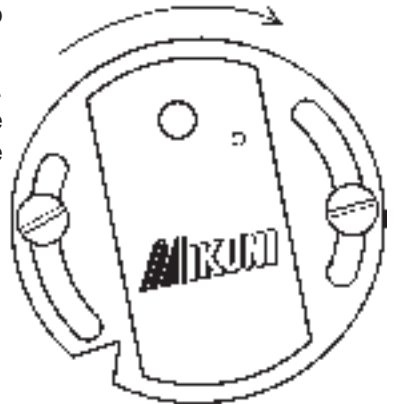

- 8) Disconnect the ground cable and then red wire from the battery.
- 9) Thread the ignition's wiring harness along the frame and up to the ignition coil. Whenever possible, run the harness along Harley's main harness and through the existing tie wraps. Where needed, use one of the supplied tie wraps to control the ignition's wire harness.
- 10) Use a crimping tool to attach the two furnished eyelet connectors to the red and black wires. After crimping, gently tug on the connectors to make sure that the connections are sound.
- 11) Add the Mikuni PAT ignition's red wire to the coil terminal with the stock white/black wire. Add the other PAT (black) ignition wire to the remaining terminal with the stock pink wire. Both Harley wires (pink & black/white) remain in place.
- 13) Use the supplied "Scotchlok" connector to attach the ignition's green wire to the "VOES" violet/white harness wire. Be sure that the PAT ignition's green wire is fully inserted into the connector before crimping.
- 14) Check all connections and the routing of the ignition harness to make sure they are soundly mounted and will not be damaged in use.

PARTS LIST:

Item	Part#	Description	Qty	Kit#
1	TM42- 6	CARBURETOR	1	15, 16
2	HS42/001	ADAPTER	1	15, 16
3	HS42/002	SCREW	3	15, 16
4	HS42/003	O-RING	1	15, 16
5	HS42/006	COVER, CLEANER	1	15, 16
10	HS42/015- 014	VENT HOSE	1	15, 16
11	Z70/045	HOSE CLAMP	1	15, 16
12	Z70/146	CABLE TIE	3	15, 16
13	N100.604-155	MAIN JET	1	15, 16
14	N100.604-165	MAIN JET	1	15, 16
15	OTHERS	PAT INSTALLATION SUPPL.	1	15, 16
16	OTHERS	HSR42/45 OWNER'S MANUAL	1	15, 16
17	KHS-021	CAM/PUSHROD/BEARING	1	15, 16
18	KHS-022	IGNITION ASSY	1	15
19	KHS-023	GASKET KIT	1	15, 16

LEGAL STUFF:

The Mikuni PAT Upgrade is an off-road product. The Mikuni PAT Upgrade kits are not designated as C.A.R.B. exempt, are not legal for motor vehicles operated on public highways in the state of CA, or in other states and countries where similar anti-pollution laws may apply.